

Instrument Case (1402 Series)

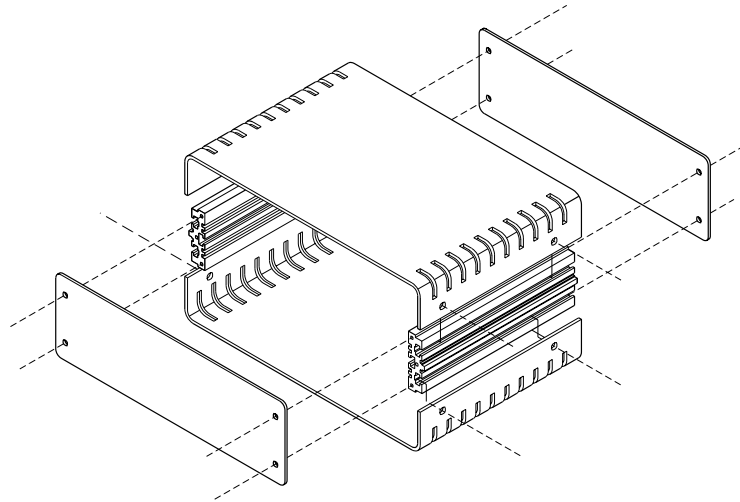
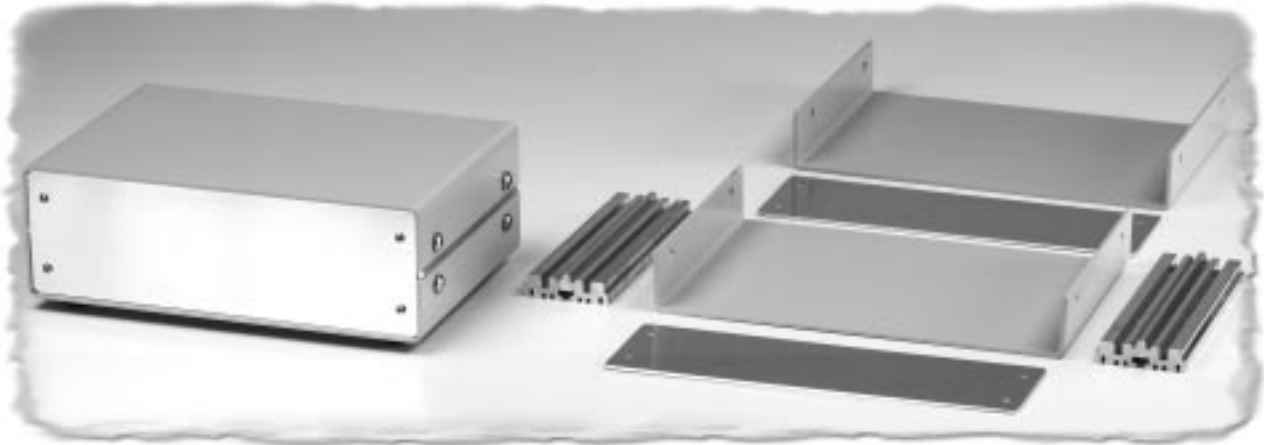

KEY FEATURES

- Top and bottom made from 12 gauge aluminum finished in contemporanea grey powder paint.
- Top and bottom are attached to an internal aluminum extrusion which contains mounting slots for printed circuit boards or panels.
- Front and rear panels are natural aluminum (paper coated one side) which are attached with screws to the aluminum mounting extrusion.
- Panels can be easily removed for access to components.
- Tops and bottoms are available in solid or with vent slots.
- All hardware and self-adhesive rubber feet are included.

Metal

Part Number		Units	Dimensions							Fits Eurocard Sizes
Solid Top and Base	Vented Top and Base		A	B	C	D	E	F	G	
1402B	1402BV	inch mm	2.4 60	7.1 181	4.9 112	6.34 161	6.16 156.5	3.93 99.82	10	160 x 100
1402D	1402DV	inch mm	2.4 60	7.1 181	7.3 185	6.34 161	6.16 156.5	5.68 144.27	14	160 x 160
1402F	1402FV	inch mm	3.1 80	7.1 181	10.3 261	6.34 161	6.16 156.5	9.18 233.2	22	160 x 234
1402H	1402HV	inch mm	3.9 99	10.0 254	7.3 185	9.25 235	9.07 230.4	5.68 144.3	14	234 x 160
1402K	1402KV	inch mm	3.9 99	10.0 254	9.6 244	9.25 235	9.07 230.4	8.30 210.8	20	234 x 220

Instrument Case (1402 Series)

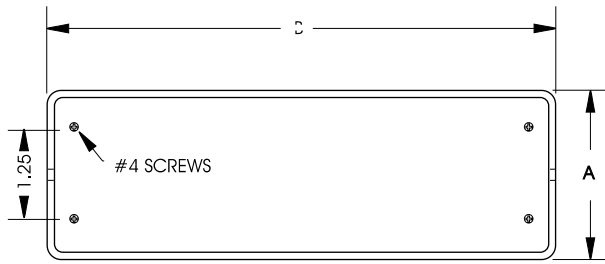

Front View - Panel Mounted

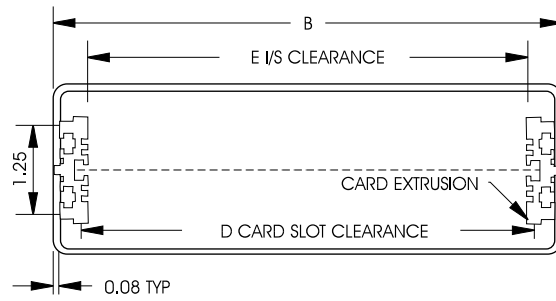

Front View - Panel Removed

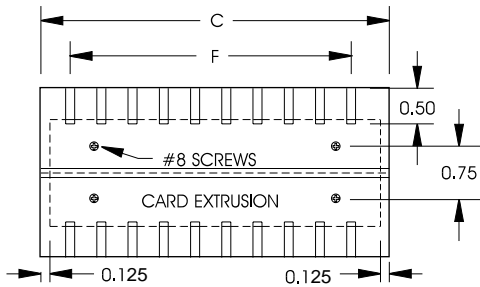

Side View (Vented)

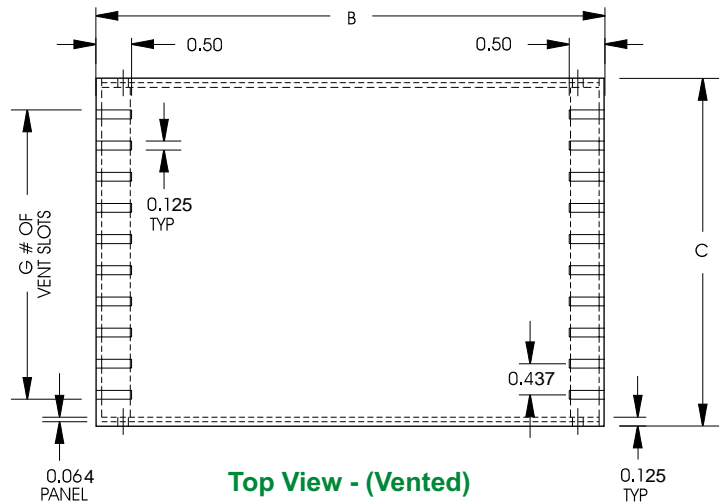

Top View - (Vented)

Front & Rear Panel Detail

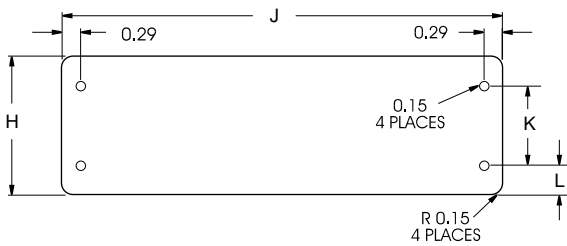

Panel for:	Units	Dimensions			
		H	J	K	L
1402B	inch	2.19	6.95	1.25	.468
	mm	55.63	176.53	31.75	11.89
1402D	inch	2.19	6.95	1.25	.468
	mm	55.63	176.53	31.75	11.89
1402F	inch	2.94	6.95	1.25	.843
	mm	74.68	176.53	31.75	21.4
1402H	inch	3.69	9.86	1.25	1.22
	mm	93.73	250.44	31.75	30.99
1402K	inch	3.69	9.86	1.25	1.22
	mm	93.73	250.44	31.75	30.99

Right & Left Side Extrusion Detail

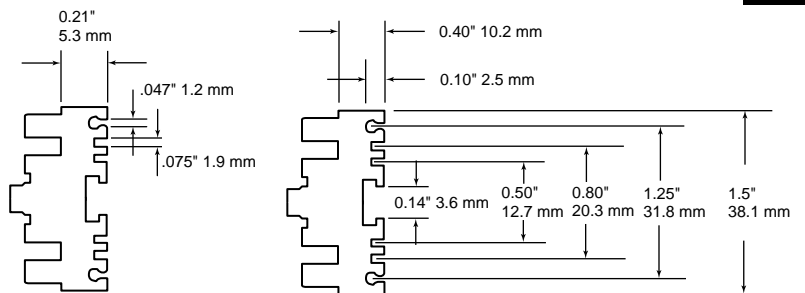

Metal



CANADA
Guelph, Ontario (519) 822-2960
St. Laurent, Quebec (514) 343-9010
USA
Cheektowaga, NY (716) 651-0086



EUROPE
Basingstoke, UK +44 1256 812812

AUSTRALASIA
Queenstown, SA, Australia +61 8 8240 2244